

MC MECHANICAL-TYPE PRECISION VICE

'LOCK-TIGHT' MACHINE VISES

CORNER Most kindly design to considered every tiny point.

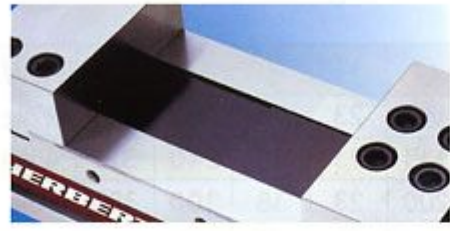

Chip cover adopted, preventing chips falling into causing bad motion.

Double opening than those of same grade vice. Can easy clamp longer work piece.

Max. opening capacity 300 mm.



The jaw more deeper than those of same grade vice.. Can clamping higher work piece correctly.

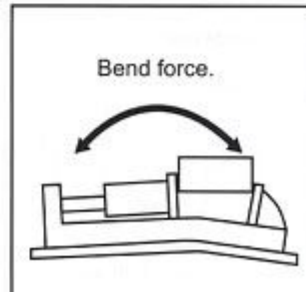

High strength. High accuracy.

Perpendicular rib structure which strain of vice. It could hardly due

— 7 —

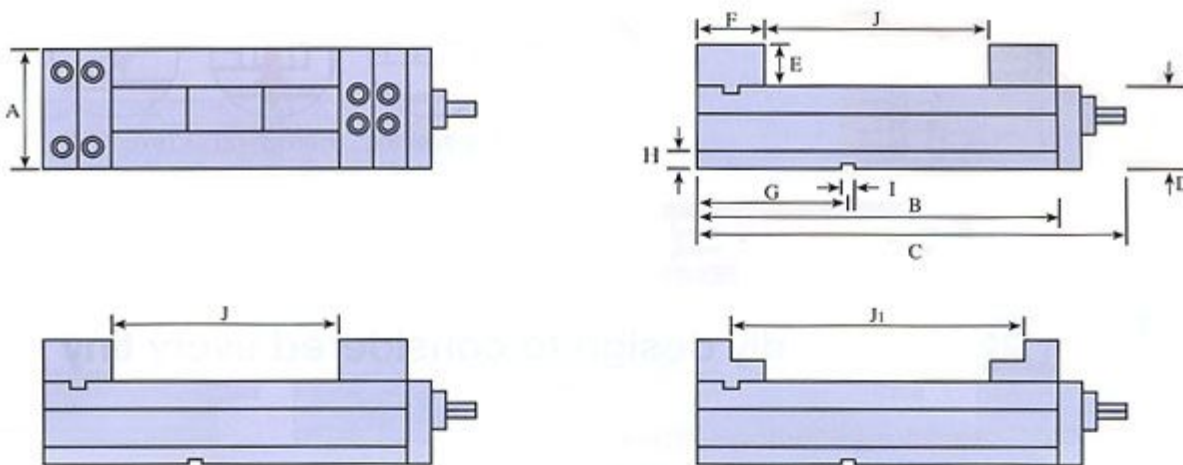

MODEL	A	B	C	D	E	F	G	H	I	J	J ₁	N.W.	G.W.	POWER
VCP-100	100	310	400	95	45	70	110	23	18	150	225	25kg	28kg	-
VCP-130	130	410	500	100	50	75	135	23	18	250	330	43kg	46kg	-
VCP-160	160	490	580	110	55	85	200	23	18	300	385	57kg	60kg	-
VCP-200	200	565	655	120	60	100	220	23	18	350	450	97kg	100kg	-

PATENT NUMBER
249762
256286

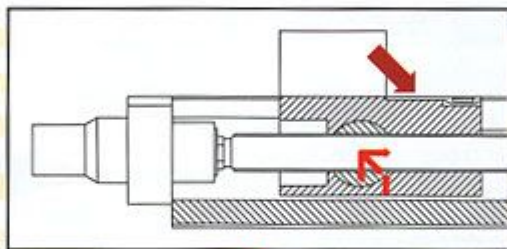

This unit had prevent lifting structure, when clamping in down direction power also acting, so the workpiece and movable parts lift very small, furthermore, the body and solid jaw is a combination structure, it does not tilt.



The whole Swivel Base are made by Stainless Steel, with harden treatment, durable and high accurate.

Standard Accessories

- 1.Handle-1 set
- 2.Guide key-2pcs
- 3.Screw-M6x10Lx2pcs
- 4.Chip cover
- 5.Vise locked block-4pcs

- 1.Special application jaw plates
- 2.Vise positioner
- 3.Swivel Base
- 4.Opening jaw plates
- 5.Sleeve spanner

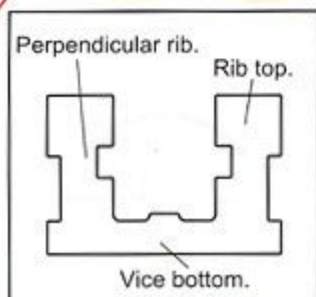

has great resistance to bending to clamping to bring bend.



Ductile cast iron spring.



Microphotograph for ductile cast iron

Ductile cast iron is fit to produce rigid precision items, which have three times strengthen than same grade vise due to used ductile cast iron.



The common contact face and slide face of movable parts both with good wear resistance of treat treatment (over HRC45')

— 8 —

SUPER OPEN TYPE

'LOCK-TIGHT' MACHINE VISES

CORNER Most kindly design to considered every tiny point.

PRESSURE POSITION SYSTEM

New development patented, oil-free powerful mechanical boost system, which gives greater clamping and never collapsing pressure.



0	DIRECT
1	800kgf
2	2000kgf
3	3000kgf
4	4000kgf
5	5000kgf

Chip cover adopted, preventing chips falling into causing bad motion.



Max. opening capacity 300 mm.

Double opening than those of same grade vise. Can easy clamp longer work piece.

The jaw more deeper than those of same grade vise.. Can clamping higher work piece correctly.

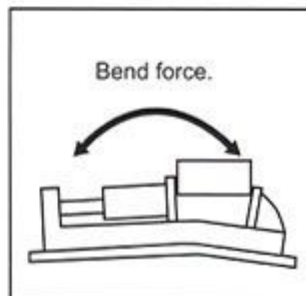

High strength. High accuracy.

Perpendicular rib structure which strain of vise. It could hardly due

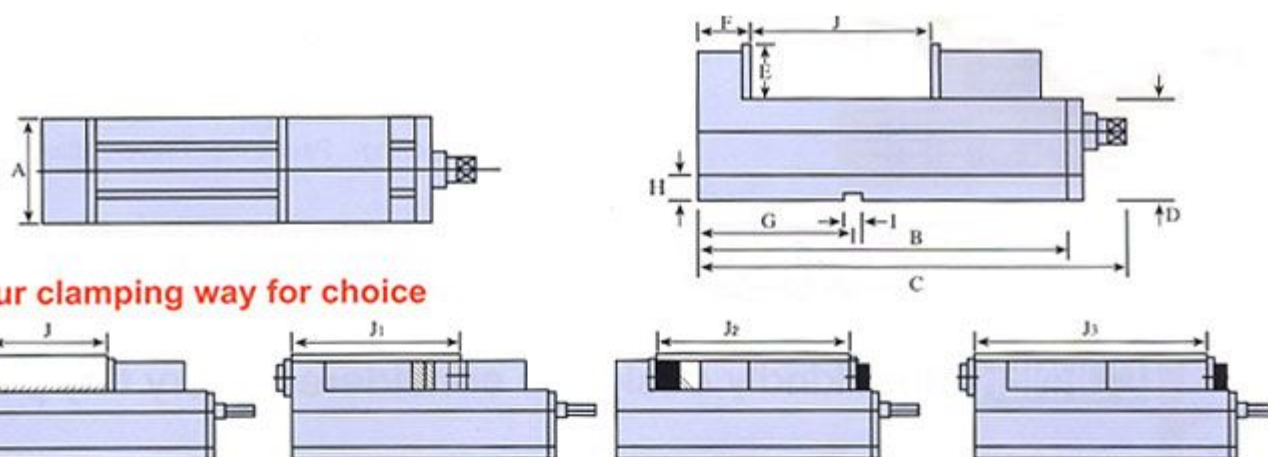

MODEL	A	B	C	D	E	F	G	H	I	J	J ₁	J ₂	J ₃	N.W.	G.W.	POWER
VIP-100	100	400	530	85	45	80	110	23	18	200	230	260	340	32kg	35kg	4000kgf
VIP-130	130	450	580	95	50	85	135	23	18	240	285	320	405	45kg	48kg	4500kgf
VIP-160	160	550	680	100	60	103	200	23	18	300	380	400	500	63kg	66kg	5000kgf
VIP-200	200	600	730	110	60	108	220	23	18	340	438	470	578	92kg	104kg	5500kgf

PATENT NUMBER
 184869 201150
 249761 256258
 GERMANY 201125447
 CHINA ZL01231630X



This unit had prevent lifting structure, when clamping in down direction power also acting, so the workpiece and movable parts lift very small, furthermore, the body and solid jaw is a combination structure, it does not tilt.



The whole Swivel Base are made by Stainless Steel, with harden treatment, durable and high accurate.

Standard Accessories

- 1.Handle-1 set
- 2.Guide key-2pcs
- 3.Screw-M6x10Lx2pcs
- 4.Chip cover
- 5.Vise locked block-4pcs

Optional Accessories

- 1.Special application jaw plates
- 2.Vise positioner
- 3.Swivel Base
- 4.Opening jaw plates
- 5.Sleeve spanner

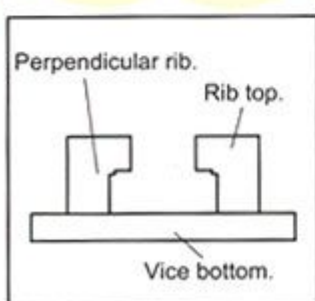

has great resistance to bending to clamping to bring bend.



Ductile cast iron spring.



Microphotograph for ductile cast iron

Ductile cast iron is fit to produce rigid precision items, which have three times strengthen than same grade vise due to used ductile cast iron.

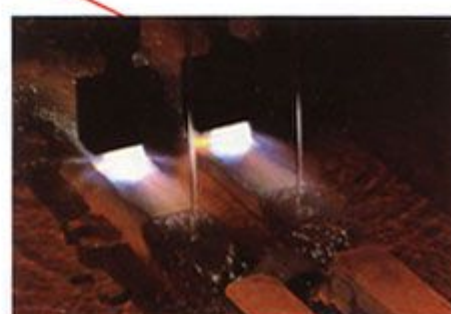

The common contact face and slide face of movable parts both with good wear resistance of treat heatment (over HRC45°)



Powerful

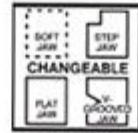

Change



Paralleling



Prevent lifting

SUPER OPEN TYPE

'LOCK-TIGHT' MACHINE VISES

CORNER Most kindly design to considered every tiny point.

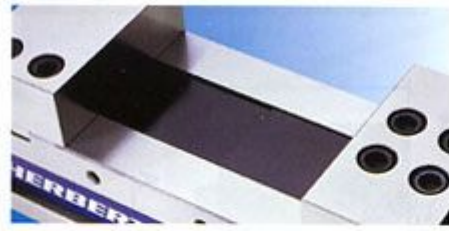

Chip cover adopted, preventing chips falling into causing bad motion.

Double opening than those of same grade vice. Can easy clamp longer work piece.

Max. opening capacity 300 mm.



New development patented, oil-free powerful mechanical boost system, which gives greater clamping and never collapsing pressure.

PRESSURE POSITION SYSTEM



0	DIRECT
1	800kgf
2	2000kgf
3	3000kgf
4	4000kgf
5	5000kgf

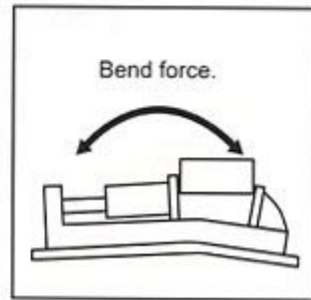

High strength. High accuracy.

Perpendicular rib structure which strain of vice. It could hardly due

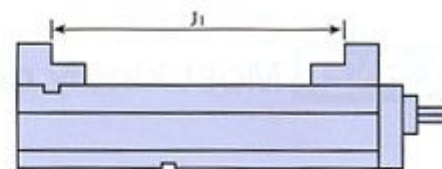
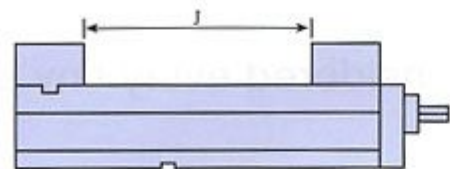
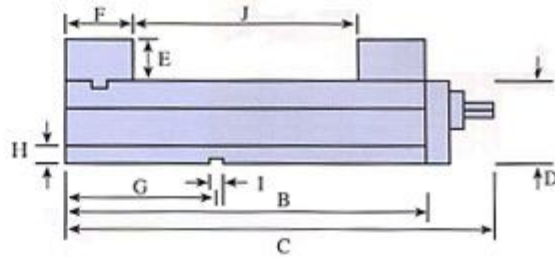
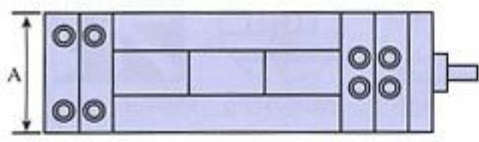

MODEL	A	B	C	D	E	F	G	H	I	J	J ₁	N.W.	G.W.	POWER
VSP-100	100	310	425	95	45	70	110	23	18	150	200	27kg	30kg	4000kgf
VSP-130	130	410	525	100	50	75	135	23	18	240	315	45kg	48kg	4000kgf
VSP-160	160	490	610	110	55	85	200	23	18	300	385	60kg	62kg	5000kgf
VSP-200	200	565	680	120	60	100	220	23	18	350	450	100kg	105kg	5000kgf

PATENT NUMBER
 184869 201150 249761
 256286 249762
GERMANY 201125447
CHINA ZL01231630X

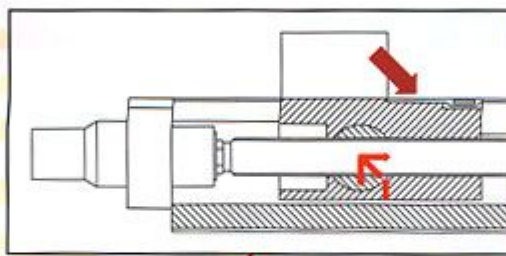

This unit had prevent lifting structure, when clamping in down direction power also acting, so the workpiece and movable parts lift very small, furthermore, the body and solid jaw is a combination structure, it does not tilt.



The whole Swivel Base are made by Stainless Steel, with harden treatment, durable and high accurate.

Standard Accessories

1. Handle-1 set
2. Guide key-2pcs
3. Screw-M6x10Lx2pcs
4. Chip cover
5. Vise locked block-4pcs

Optional Accessories

1. Special application jaw plates
2. Vise positioner
3. Swivel Base
4. Opening jaw plates
5. Sleeve spanner

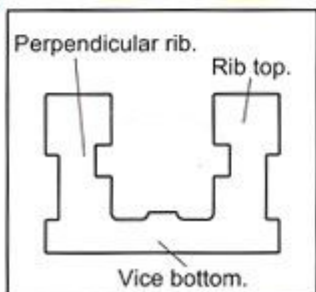

has great resistance to bending to clamping to bring bend.



Ductile cast iron spring.



Microphotograph for ductile cast iron

Ductile cast iron is fit to produce rigid precision items, which have three times strength than same grade vise due to used ductile cast iron.

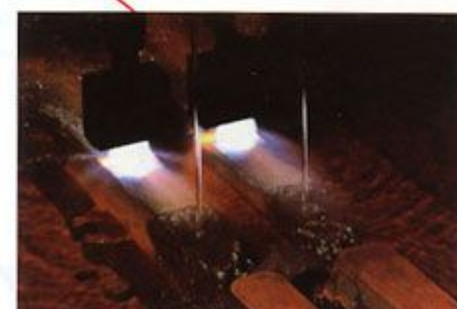

The common contact face and slide face of movable parts both with good wear resistance of treat heat treatment (over HRC45°)